

EVANESCENT MODE WAVEGUIDE FILTERS FOR 5760, 3400 MHz and 10.4GHz

Andy Talbot G4JNT July 2013

The diagram in *Figure 1* shows a bandpass filter for 3.4 GHz ^[1] constructed from Waveguide 16. Unlike more conventional waveguide filters where the resonators are formed by cavities, in this unit the resonators are screws, and the coupling between is by the waveguide operating well below its cutoff frequency. In this evanescent mode attenuation is high and results in the low value of coupling needed for narrow bandwidth filters.

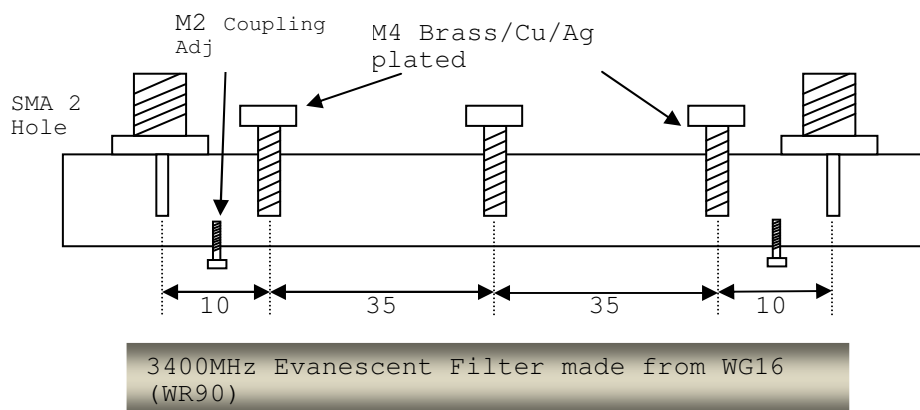

Figure 1

Coupling in and out of the filter is by SMA connectors mounted on the waveguide broad face. Inside the waveguide, the centre pin of the connector is widened to increase the coupling by soldering on a 6mm length of M4 studding with a 1.5mm hole drilled in one end to take the SMA socket centre pin. A connector with the PTFE dielectric extending along the pin is ideal. The PTFE should be cut back leaving just the waveguide wall thickness protruding from the flange. When enclosed by a 4mm hole drilled in the guide, a continuous 50Ω line to the coupling probe is obtained.

The M2 coupling screws are to achieve the ideal response shape if test equipment is available. As an alternative, the input coupling probe may be lengthened to around 7mm, and these screws may be dispensed with. It will then not be possible to achieve the ideal response shape, but for the centre part of the band a good match will be obtained. The resonator length inside the waveguide is approximately 9.5mm, leaving a gap between its end and the far wall of less than 1mm.

Alignment

If a means of measuring VSWR at the centre frequency is available, then the filter may be aligned using Dishals method. This is described in detail on page 12.16 of the Microwave Handbook (Volume 2). Alternatively, simply tuning for maximum transmission at the centre frequency will prove quite adequate.

The filter was designed for a 50 MHz bandwidth, with a 0.2dB ripple Chebyshev response. *Figure 2* shows the measured passband and stopband responses. An insertion loss of 1.2 dB was obtained using brass tuning screws, in brass waveguide. (The M2 coupling screws were steel). This figure will be significantly better using copper waveguide with silver plated screws. Return loss was better than 16dB.

[1] The filter was originally designed for 3456MHz, before the bandplan was changed. It was subsequently retuned for 3400MHz.

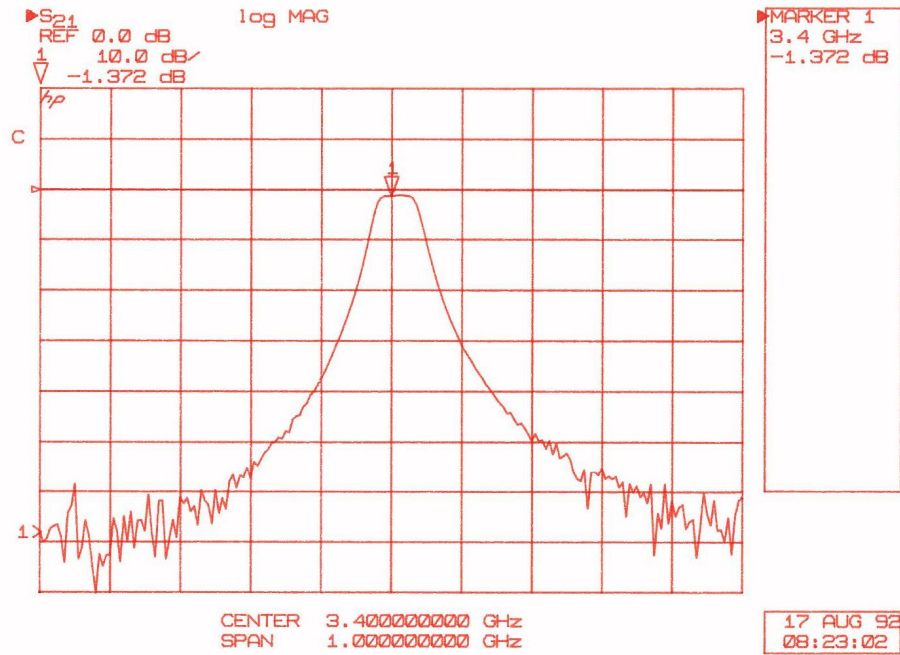

Figure 2 3.4 GHz Frequency Response

Coupling screw penetration for this response was 5mm. With no coupling screws, but keeping the 6mm probe length, a 3dB ripple response resulted, with one of the peaks of minimum attenuation at the centre of the band. As the frequency rises towards the waveguide cutoff at 6.56 GHz, attenuation falls again. At the 6.9 GHz second harmonic, an attenuation of around 25 dB was measured.

This measured performance is ideal as the frequency determining element of a 144 to 3400 MHz transverter. Local oscillator (3256 MHz) attenuation is 45 dB down and the image response is around 65 dB

Design

For further information on these filters, ^[2] provides full details of how to design them, including the details of how to make a coupling test fixture. I measured the coupling coefficients for a range of resonator spacings at the one centre frequency. For other filter shapes, orders and bandwidths **at this same centre frequency and using the same resonator diameter**, the spacing between adjacent resonators may be obtained from the following empirically determined equation.

$$D_{n,n+1} = 65.8 - 18.9 \text{ LOG}_{10} (K_{n,n+1} \cdot \text{BW})$$

Where $D_{n,n+1}$ is the spacing between adjacent resonators n and n+1 in mm

$K_{n,n+1}$ is the normalised coupling coefficient between adjacent resonators. These can be obtained from sets of filter tables. BW is the filter design bandwidth (MHz)

The input coupling probe spacing needs to be determined by trial and error, but I suspect that the distance will scale linearly with the resonator spacing.

Other Bands

The optimum waveguide has a cutoff frequency roughly 1.5 - 2 times the wanted centre frequency. Therefore for a 2.3 GHz filter, WG14 or WG15 is ideal; For 5.6 GHz WG17 or WG18 is needed. The example in ^[2] used WG19 at 9 GHz.

Figure 3 Shows a bandpass filter for 5760MHz built in WG18, with its frequency response in Figure 4. This filter was deliberately designed with the large 3dB ripple response in order to maximise the rejection while keeping a wide enough passband. It was aligned to place a ripple peak precisely on 5760MHz

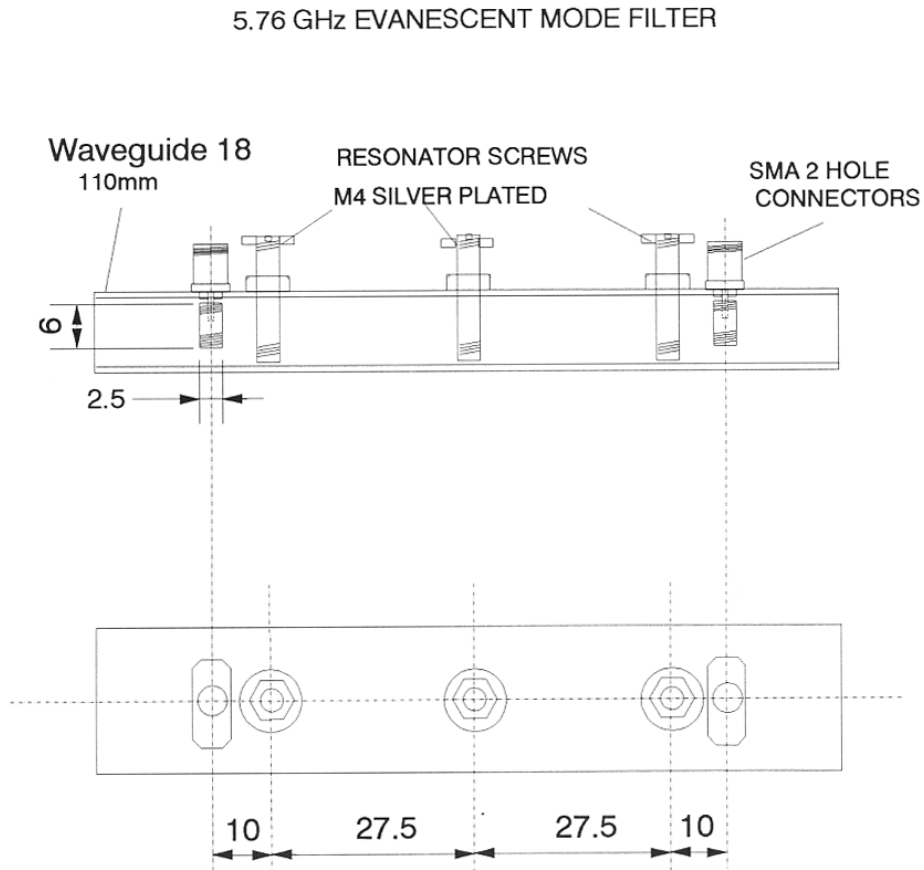

Figure 3 5.76GHz Evanescent Filter in WG18

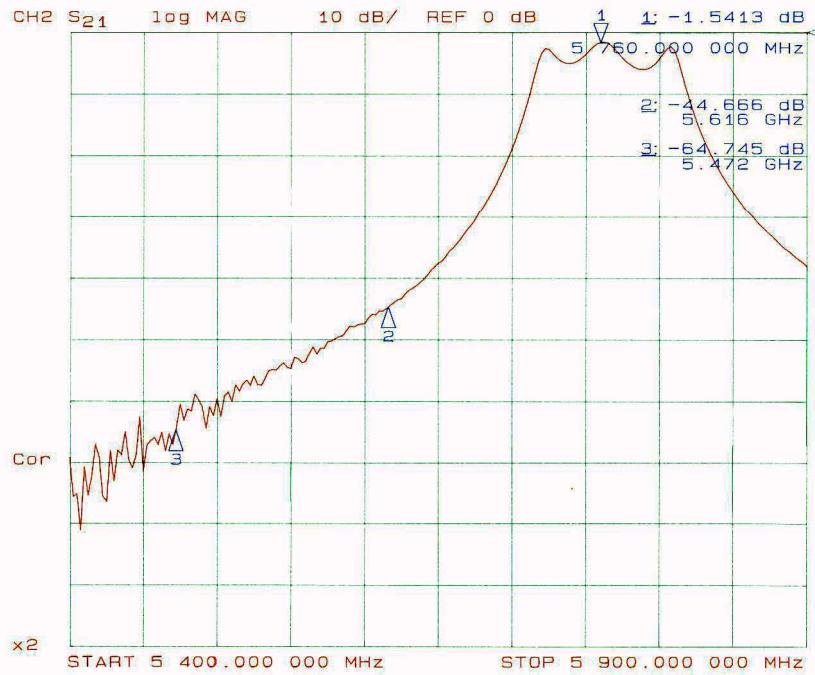
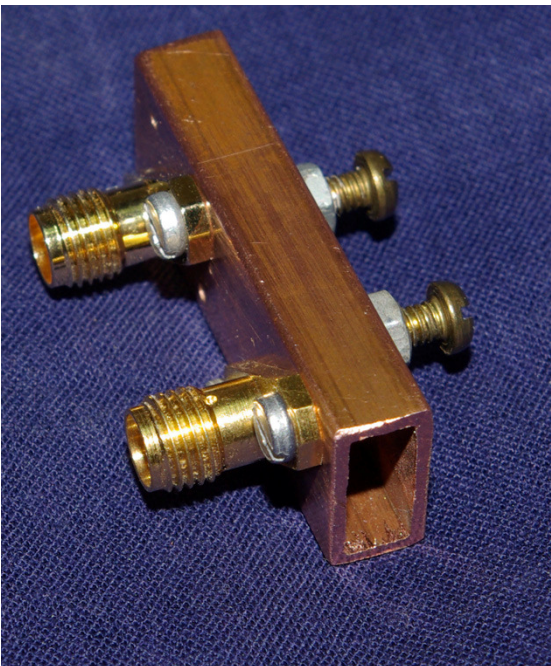

Figure 4 5.76GHz Frequency Response

10GHz Evanescent Filter

Here is a simple two section filter built in WG20 (WR42). It was intended for extracting the fourth harmonic from a 2.5GHz multiplier to make a simple beacon source.



WG20, with an internal a dimension of 10.6mm has a cutoff at 14GHz, so any filter built in this waveguide will not have brilliant performance above the passband, but is suited to attenuating the higher amplitude lower frequency outputs from a multiplier.

I roughly scaled the values from the 3.4GHz filter in WG10, and guesstimated a resonator spacing of 13mm. The resonators

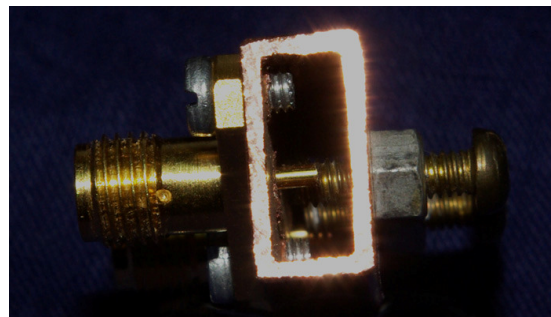

consist of 6BA brass screws (see note below) with suitable holes drilled and tapped into the WG broad face.

Input and output coupling probes were made from the spigots of SMA sockets mounted on the waveguide using M2.5 screws into threads tapped into the waveguide as shown in the photographs. The coupling probes were spaced 3mm from the resonators (19mm spacing between the two ports), and mounted on the opposite face of the waveguide. I started out with a probe length half the width of the waveguide, intending to trim this if the initial frequency response looked too much like a camel.

It wasn't worth setting up for a Dishal tuning procedure with a simple filter like this so using the maximum smoke approach, both tuning screws were adjusted to give the response shown.

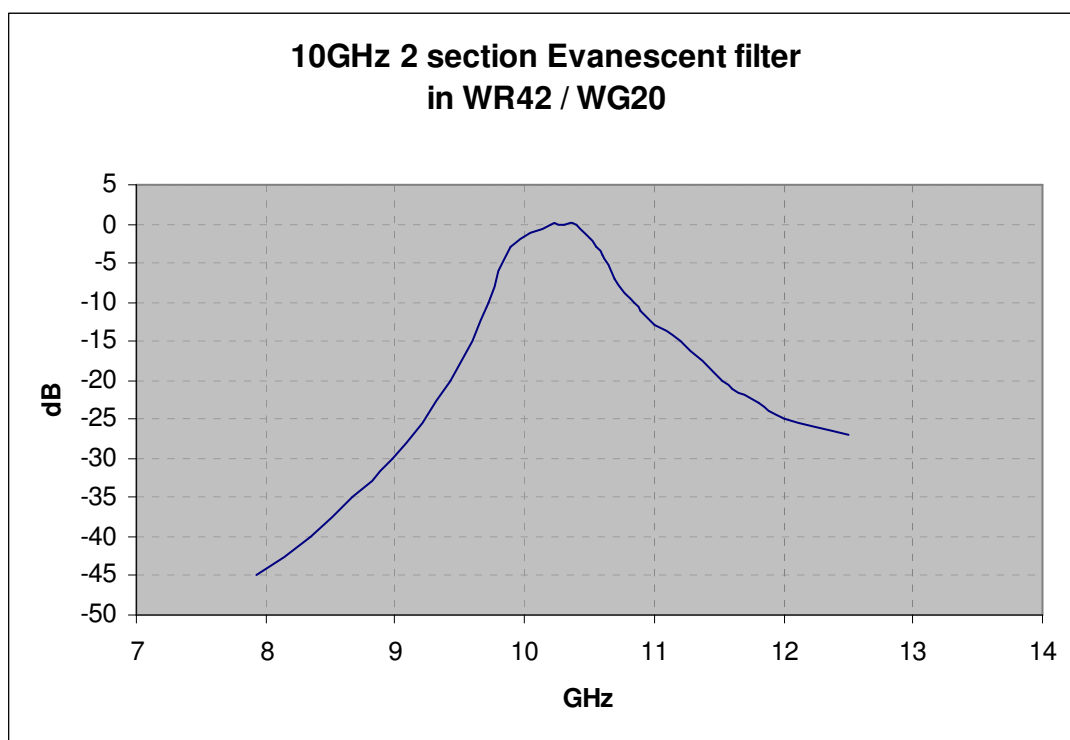

This was about what I expected; coupling wasn't so way-out that a double hump resulted so I didn't bother changing probe length. It may possibly benefit from slightly longer probes if a flatter response is essential, but that would compromise the cutoff region. The filter did what I wanted so left it alone.

The important point on the response is at 7.5GHz, the unwanted third harmonic from the multiplier, and this is attenuated by around 50dB. With my spectrum analyser, it was impossible to measure the response much below 50dB. Insertion loss at the peak of the curve, at 10.37MHz is around 2.5 to 3dB; the 3dB bandwidth 9.89 to 10.56GHz

- [2] *"Evanescent-Mode Waveguide Filters Built in a Day",
Microwaves and RF, July 1987, pp 117 - 124.*

The design for 3.4GHz was originally published in the RSGB Microwave Newsletter in January 1991.

The 5.76GHz design appeared there several years later.

The 10GHz design appeared in Scatterpoint in 2013

Note on filter tuning screws.

Back in the year dot, when I worked in an RF industry that actually built real hardware, at the bench next to a bunch of satellite filter gurus...

One of them once told me that BA threads were preferred for filter tuning because the shallower thread helix angle of 47.5° gives a deeper thread cut that allows better metal-to-metal contact than the 60° helix angle of metric threads. Since I have a 6BA tap, it's a piece of advice I've followed ever since.